

Aluminum Ladder/Ventilated Tray

LEA73/VEA73 Series

CSA Load Class:E

Manufactured in Canada by Niedax CER

LEA73/VEA73 STRAIGHT SECTION

General Information

TRAY DESIGN: Construction and markings are per the latest edition of CSA C22.2 No.126.

TRAY GROUNDING CAPABILITY: Classified as an equipment grounding conductor per N.E.C. 392.7 with a maximum 1600 ampere rating UL Cross Sectional area:2.48 in²

CONNECTORS: Supplied in pairs with hardware. Splice resistance is less than 0.00033 ohms. Standard hardware: 5/16" cadmium-plated with clear zinc topcoat. Stainless steel hardware is available upon request.

Material: Aluminum 6063-T6 Alloy

Load Rating*: 200lbs/ft with supports at 10ft apart.

*Load rating is based on simple beam tests per NEMA VE1 on 36" wide cable tray with rungs spaced on 12" centers. Cable trays will support, without collapse, concentrated load over and above published loads. Published load safety factor is 1.5.

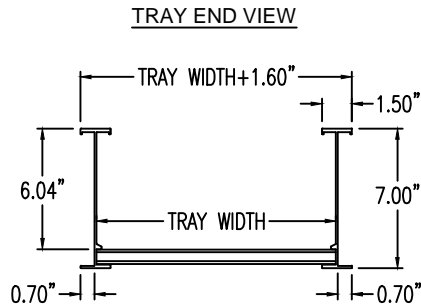

Siderail: 7"
Load Depth: 6.04"

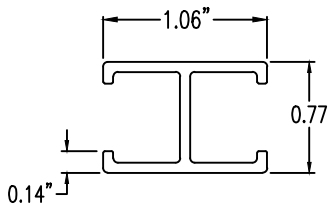

RUNG END VIEW

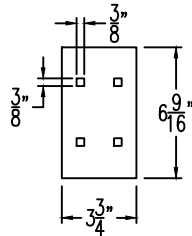

COUPLING



ALUMINUM LADDER/VENTILATED TRAY ORDERING DATA EXAMPLE

LEA73 - (Width) - (Rung)

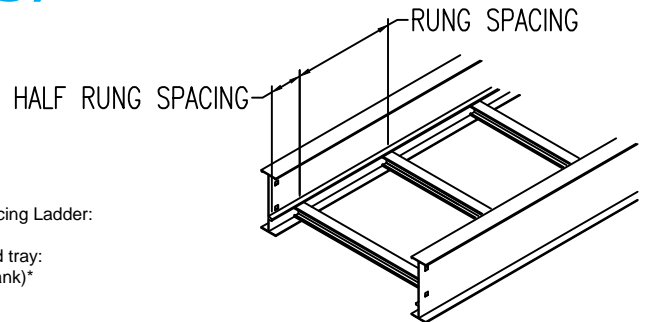
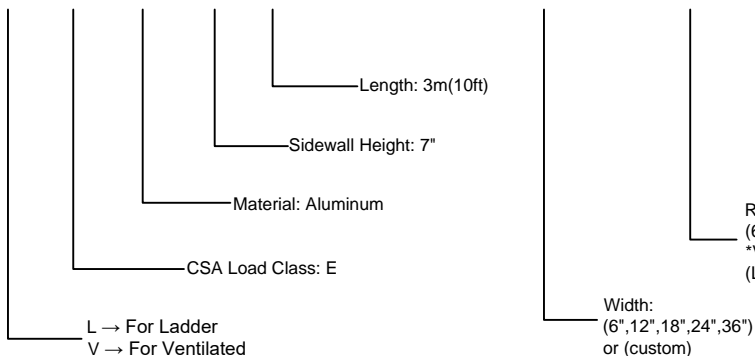

NOTES:

* CSA Ventilated tray has a rung spacing of 4" between rungs.

2799 Barton St E
Hamilton, ON L8E 2J8
Toll Free: 1 877.213.8045
Phone:905.337.7522
Cerinc.ca

